



# PMAC Controller SIO

1	System Configuration.....	3
2	Selection of External Device .....	6
3	Example of Communication Setting .....	7
4	Setup Items .....	10
5	Cable Diagram .....	15
6	Supported Devices.....	17
7	Device Code and Address Code.....	18
8	Error Messages.....	19

## Introduction

This manual describes how to connect the Display and the External Device (target PLC).

In this manual, the connection procedure will be described by following the below sections:

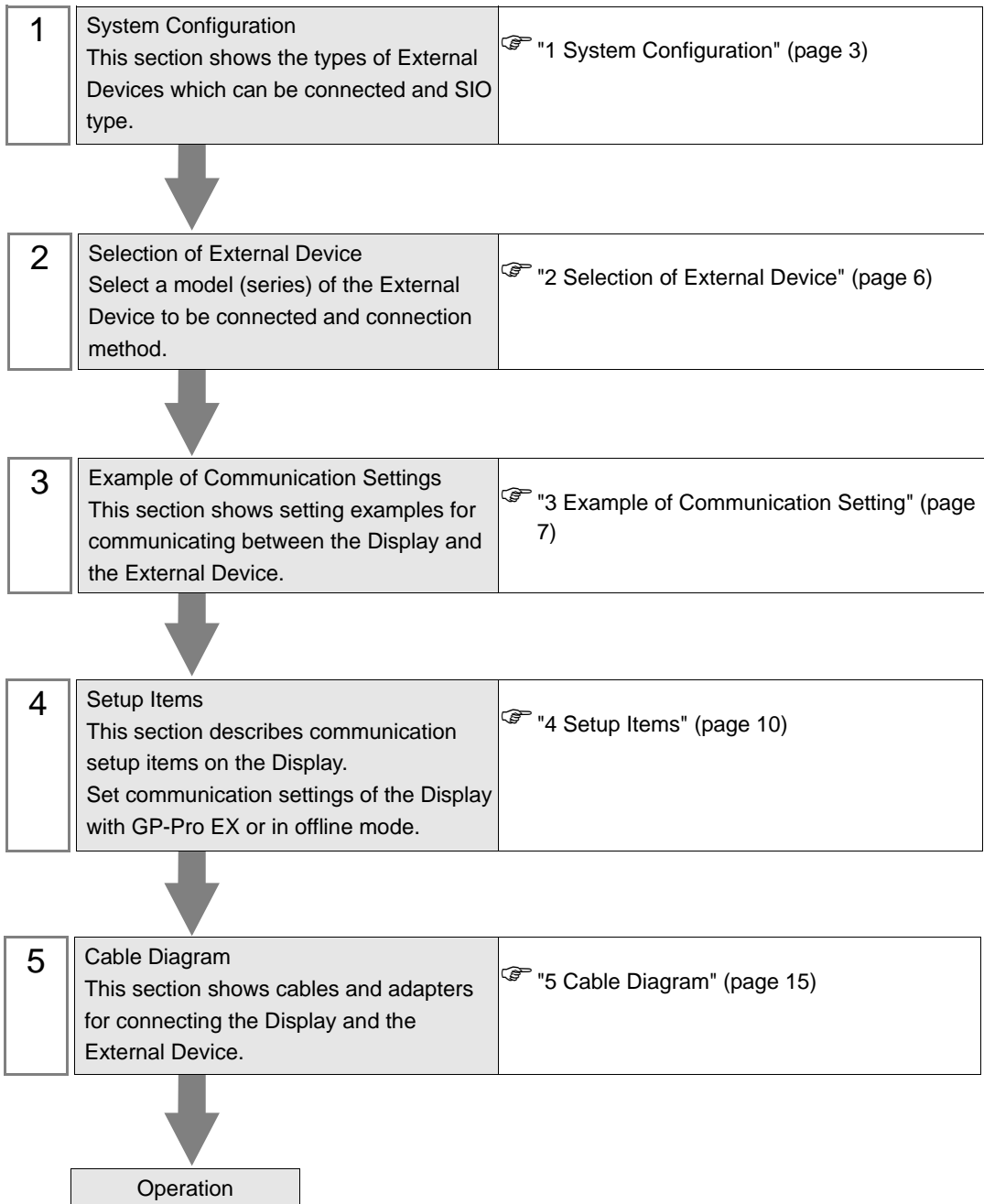

# 1 System Configuration

The system configuration in the case when the External Device of Delta-TAU data system, inc. and the Display are connected is shown.

Series	CPU	Link I/F	SIO Type	Setting Example	Cable Diagram
PMAC	PC/104 PMAC-Lite PMAC-PC	Serial Port on CPU	RS-232C	"Setting Example 1" (page 7)	"Cable Diagram 1" (page 15)
Turbo PMAC	Turbo PMAC1 Turbo PMAC2 Turbo Clipper QMAC Geo Brick Controller Geo PMAC Driver PC/104 Turbo Turbo PMAC PCI	Serial Port on CPU	RS-232C	"Setting Example 1" (page 7)	"Cable Diagram 1" (page 15)
	UMAC	Serial Port on CPU	RS-232C	"Setting Example 1" (page 7)	"Cable Diagram 1" (page 15)
		Aux Port on CPU*1	RS-232C	"Setting Example 1" (page 7)	"Cable Diagram 1" (page 15)

\*1 This port can be used for general communications. It is possible to turn off the command parser for this port by setting variable I43 to 1, so Turbo PMAC does not try to interpret incoming characters as commands, making it possible for the user to parse incoming data as he pleases.

## ■ Connection Configuration

- 1:1 connection



## ■ IPC COM Port

When connecting IPC with an External Device, the COM port used depends on the series and SIO type. Please refer to the IPC manual for details.

### Usable port

Series	Usable Port		
	RS-232C	RS-422/485(4 wire)	RS-422/485(2 wire)
PS-2000B	COM1 <sup>*1</sup> , COM2, COM3 <sup>*1</sup> , COM4	-	-
PS-3450A, PS-3451A, PS3000-BA, PS3001-BD	COM1, COM2 <sup>*1*2</sup>	COM2 <sup>*1*2</sup>	COM2 <sup>*1*2</sup>
PS-3650A (T41 model), PS-3651A (T41 model)	COM1 <sup>*1</sup>	-	-
PS-3650A (T42 model), PS-3651A (T42 model)	COM1 <sup>*1*2</sup> , COM2	COM1 <sup>*1*2</sup>	COM1 <sup>*1*2</sup>
PS-3700A (Pentium®4-M) PS-3710A	COM1 <sup>*1</sup> , COM2 <sup>*1</sup> , COM3 <sup>*2</sup> , COM4	COM3 <sup>*2</sup>	COM3 <sup>*2</sup>
PS-3711A	COM1 <sup>*1</sup> , COM2 <sup>*2</sup>	COM2 <sup>*2</sup>	COM2 <sup>*2</sup>
PS4000 <sup>*3</sup>	COM1, COM2	-	-
PL3000	COM1 <sup>*1*2</sup> , COM2 <sup>*1</sup> , COM3, COM4	COM1 <sup>*1*2</sup>	COM1 <sup>*1*2</sup>

\*1 The RI/5V can be switched. Use the IPC's switch to change if necessary.

\*2 Set up the SIO type with the DIP Switch. Please set up as follows according to SIO type to be used.

\*3 When making communication between an External Device and COM port on the Expansion slot, only RS-232C is supported. However, ER (DTR/CTS) control cannot be executed because of the specification of COM port.

For connection with External Device, use user-created cables and disable Pin Nos. 1, 4, 6 and 9. Please refer to the IPC manual for details of pin layout.

### DIP Switch setting: RS-232C

DIP Switch	Setting	Description
1	OFF <sup>*1</sup>	Reserved (always OFF)
2	OFF	SIO type: RS-232C
3	OFF	
4	OFF	Output mode of SD (TXD) data: Always output
5	OFF	Terminal resistance (220Ω) insertion to SD (TXD): None
6	OFF	Terminal resistance (220Ω) insertion to RD (RXD): None
7	OFF	Short-circuit of SDA (TXA) and RDA (RXA): Not available
8	OFF	Short-circuit of SDB (TXB) and RDB (RXB): Not available
9	OFF	RS (RTS) Auto control mode: Disabled
10	OFF	

\*1 When using PS-3450A, PS-3451A, PS3000-BA and PS3001-BD, turn ON the set value.

DIP Switch setting: RS-422/485 (4 wire)

DIP Switch	Setting	Description
1	OFF	Reserved (always OFF)
2	ON	SIO type: RS-422/485
3	ON	
4	OFF	Output mode of SD (TXD) data: Always output
5	OFF	Terminal resistance (220Ω) insertion to SD (TXD): None
6	OFF	Terminal resistance (220Ω) insertion to RD (RXD): None
7	OFF	Short-circuit of SDA (TXA) and RDA (RXA): Not available
8	OFF	Short-circuit of SDB (TXB) and RDB (RXB): Not available
9	OFF	RS (RTS) Auto control mode: Disabled
10	OFF	

DIP Switch setting: RS-422/485 (2 wire)

DIP Switch	Setting	Description
1	OFF	Reserved (always OFF)
2	ON	SIO type: RS-422/485
3	ON	
4	OFF	Output mode of SD (TXD) data: Always output
5	OFF	Terminal resistance (220Ω) insertion to SD (TXD): None
6	OFF	Terminal resistance (220Ω) insertion to RD (RXD): None
7	ON	Short-circuit of SDA (TXA) and RDA (RXA): Available
8	ON	Short-circuit of SDB (TXB) and RDB (RXB): Available
9	ON	RS (RTS) Auto control mode: Enabled
10	ON	

## 2 Selection of External Device

Select the External Device to be connected to the Display.

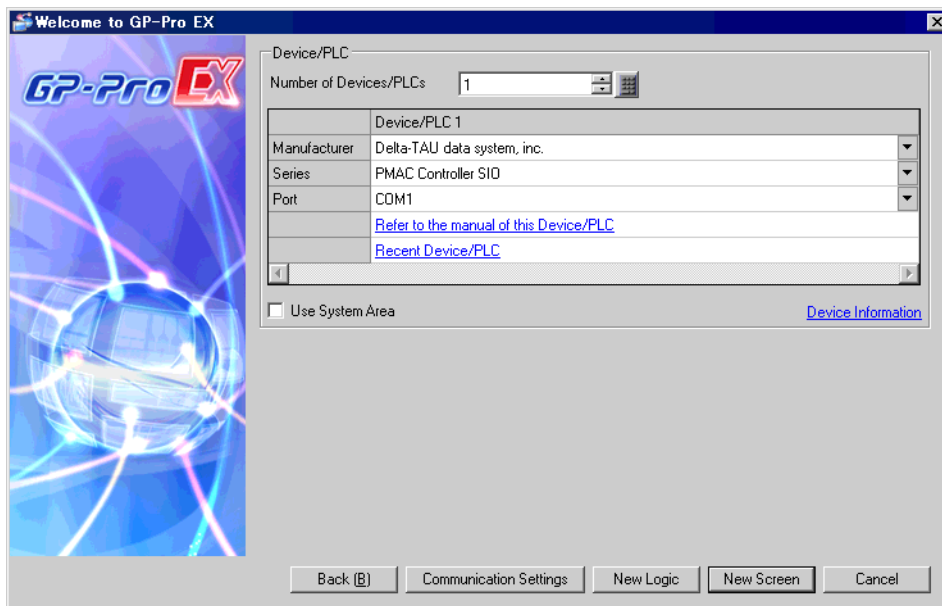

Setup Items	Setup Description
Number of Devices/PLCs	Use an integer from 1 to 4 to enter the number of Devices/PLCs to connect to the display.
Manufacturer	Select the manufacturer of the External Device to be connected. Select "Delta-TAU data system, inc.".
Series	Select the model (series) of the External Device to be connected and connection method. Select "PMAC Controller SIO". Check the External Device that you can connect in "PMAC Controller SIO" in system configuration. ☞ "1 System Configuration" (page 3)
Port	Select the Display port to be connected to the External Device.
Use System Area	Check this option when you synchronize the system data area of Display and the device (memory) of External Device. When synchronized, you can use the ladder program of External Device to switch the display or display the window on the Display. Cf. GP-Pro EX Reference Manual "LS Area (Direct Access Method Area)" This can also be set in GP-Pro EX or in the Display's offline mode. Cf. GP-Pro EX Reference Manual "Display Unit (System Area) Settings Guide" Cf. Maintenance/Troubleshooting Manual "Main Unit - System Area Settings"

### 3 Example of Communication Setting

The following shows examples of communication settings of the Display and the External Device, which is recommended by Pro-face.

#### 3.1 Setting Example 1

##### ■ Settings of GP-Pro EX

##### ◆ Communication Settings

To display the setup screen, from the [Project] menu, point to [System Settings] and select [Device/PLC].

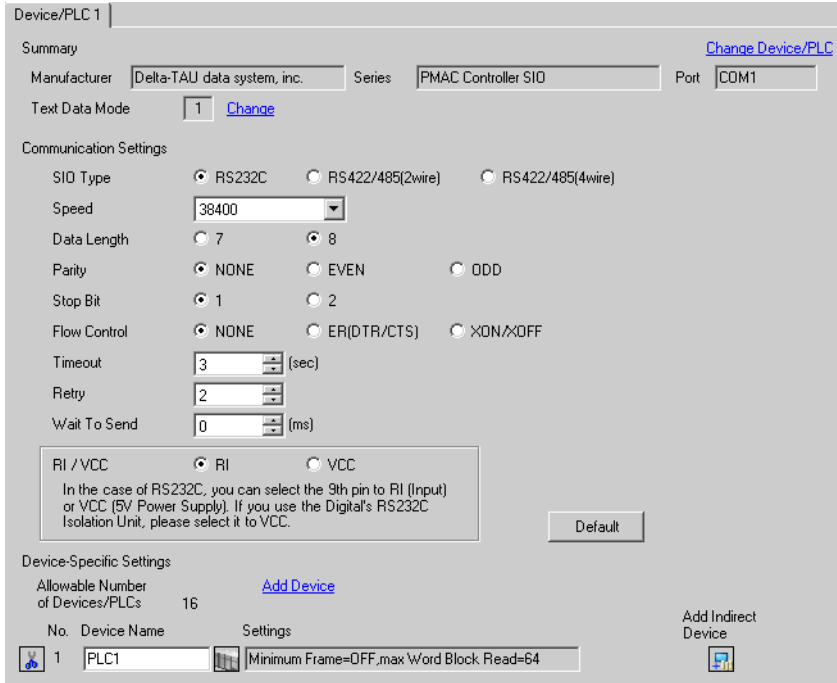

##### ◆ Device Setting

To display the [Individual Device Settings] dialog box, from [Device-Specific Settings] in the [Device/PLC] window, select the external device and click [Settings] .

To connect multiple External Devices, from [Device-Specific Settings] in the [Device/PLC] window, click [Add Device] to add another External Device.

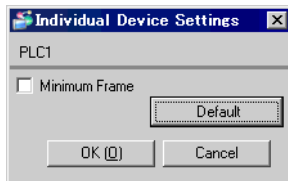

**NOTE** • If Minimum Frame is checked, Device Address Parts on communication Frame becomes a minimum length.

## ■ Settings of External Device

Use the Delta-TAU System PMAC Executive Pro Suite (Pewin32 Pro) to configure communication settings for the External Device.

Refer to your External Device manual for details.

- 1 Start up PMAC Executive Pro Suite (Pewin32 Pro).
- 2 From the [Setup] menu, select [Force All Windows to Device Number].
- 3 In the [PMAC Devices] dialog box, click [Insert] to insert a communication port.
- 4 In the [Available PMAC Devices] dialog box, click [New] to create a PMAC device .
- 5 In the [Configure Ethernet Devices] dialog box, select [PmacETH0] and define the IP address of the PMAC controller.
- 6 Select the PMAC ETH0 port and click [OK].
- 7 From the [View] menu, select [Terminal].
- 8 In the Terminal dialog box, define the Setup Items (I53, I54, I3, I4, I6)

Setup Items	Type Value
Baud Rate	I53=12, I54=12*1
Data Length	-
Stop Bit	-
Parity	-
Flow Control	-
I/O handshake Control	I3=2
Communication Integrity Mode	I4=2
Error Reporting Mode	I6=1

\*1 Serial Port is I54, Auxiliary Serial Port is I53. Please refer to “Auxiliary Serial Port Baud Rate Control” below.

- 9 To save your changes in the Terminal dialog box, use the “SAVE” command. To reset, use the “\$\$\$” command.

### Auxiliary Serial Port Baud Rate Control

- I53

Setting Value	Baud rate	Setting Value	Baud rate
0	Disabled	8	9600
1	600	9	14400
2	1200	10	19200
3	1800	11	28800
4	2400	12	38400
5	3600	13	57600
6	4800	14	76800
7	7200	15	115200



- I54

Setting Value	Baud rate	Setting Value	Baud rate
0	600	8	9600
1	900	9	14400
2	1200	10	19200
3	1800	11	28800
4	2400	12	38400
5	3600	13	57600
6	4800	14	76800
7	7200	15	115200

## 4 Setup Items

Set communication settings of the Display with GP-Pro EX or in offline mode of the Display.

The setting of each parameter must be identical to that of External Device.

 "3 Example of Communication Setting" (page 7)

### 4.1 Setup Items in GP-Pro EX

#### ■ Communication Settings

To display the setup screen, from the [Project] menu, point to [System Settings] and select [Device/PLC].

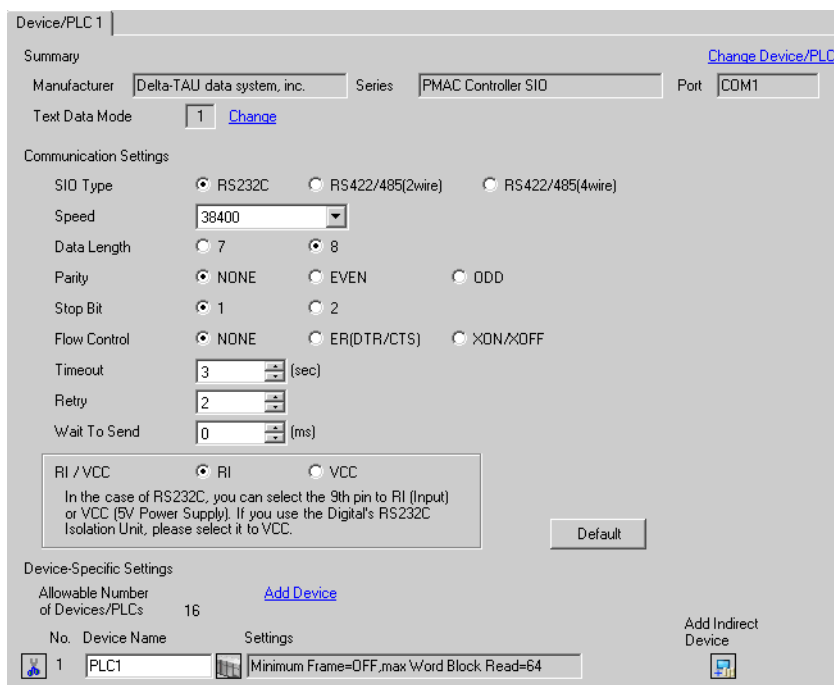

Device/PLC 1

Summary [Change Device/PLC](#)

Manufacturer  Series  Port

Text Data Mode  [Change](#)

Communication Settings

SIO Type  RS232C  RS422/485(2wire)  RS422/485(4wire)

Speed

Data Length  7  8

Parity  NONE  EVEN  ODD

Stop Bit  1  2

Flow Control  NONE  ER(DTR/CTS)  XON/XOFF

Timeout  (sec)

Retry

Wait To Send  (ms)

RI / VCC  RI  VCC

In the case of RS232C, you can select the 9th pin to RI (Input) or VCC (5V Power Supply). If you use the Digital's RS232C Isolation Unit, please select it to VCC.

Device-Specific Settings

Allowable Number of Devices/PLCs  [Add Device](#)

No.	Device Name	Settings
 1	<input type="text" value="PLC1"/>	<input type="text" value="Minimum Frame=OFF,max Word Block Read=64"/>

[Add Indirect Device](#) 

Setup Items	Setup Description
SIO Type	Select the SIO type to communicate with the External Device.
Speed	Select speed between the External Device and the Display.
Data Length	Select data length.
Parity	Select how to check parity.
Stop Bit	Select stop bit length.
Flow Control	Select the communication control method to prevent overflow of transmission and reception data.
Timeout	Use an integer from 1 to 127 to enter the time (s) for which the Display waits for the response from the External Device.
Retry	In case of no response from the External Device, use an integer from 0 to 255 to enter how many times the Display retransmits the command.
Wait To Send	Use an integer from 0 to 255 to enter standby time (ms) for the Display from receiving packets to transmitting next commands.

Setup Items	Setup Description
RI/VCC	You can toggle between RI and VCC on the 9th pin when the SIO type is RS232C. When you connect to the IPC, to toggle between RI and 5V, use the IPC's changeover switch. Please refer to the manual of the IPC for more details.

**NOTE**

- Refer to the GP-Pro EX Reference Manual for Indirect Device.  
Cf. GP-Pro EX Reference Manual "Changing the Device/PLC at Runtime (Indirect Device)"

■ Device Setting

To display the [Individual Device Settings] dialog box, from [Device-Specific Settings] in the [Device/PLC] window, select the external device and click [Settings]  .

To connect multiple External Devices, from [Device-Specific Settings] in the [Device/PLC] window, click [Add Device] to add another External Device.

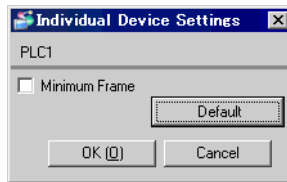

Setup Items	Setup Description
Minimum Frame	Select the Minimum Frame check box to minimize the length of device addresses in communication frames.  For example, M0009 is converted to M9.

## 4.2 Setup Items in Offline Mode

**NOTE**

- Please refer to Maintenance/Troubleshooting Guide for more information on how to enter offline mode or about operation.  
Cf. Maintenance/Troubleshooting Guide "Offline Mode"
- The number of the setup items to be displayed for 1 page in the offline mode depends on the Display in use. Please refer to the Reference manual for details.

■ Communication Settings

To display the setting screen, touch [Device/PLC Settings] from [Peripheral Settings] in offline mode. Touch the External Device you want to set from the displayed list.

Comm.	Device	Option		
PMAC Controller SIO			[COM1]	Page 1/1
SIO Type		RS232C		
Speed		38400		
Data Length		<input type="radio"/> 7 <input checked="" type="radio"/> 8		
Parity		<input checked="" type="radio"/> NONE <input type="radio"/> EVEN <input type="radio"/> ODD		
Stop Bit		<input checked="" type="radio"/> 1 <input type="radio"/> 2		
Flow Control		NONE		
Timeout(s)			3	▼ ▲
Retry			2	▼ ▲
Wait To Send(ms)			0	▼ ▲
Exit		Back		2013/05/16 17:01:44

Setup Items	Setup Description
SIO Type	Select the SIO type to communicate with the External Device. <b>IMPORTANT</b> To make the communication settings correctly, confirm the serial interface specifications of Display unit for [SIO Type]. We cannot guarantee the operation if a communication type that the serial interface does not support is specified. For details concerning the serial interface specifications, refer to the manual for Display unit.
Speed	Select speed between the External Device and the Display.
Data Length	Select data length.
Parity	Select how to check parity.
Stop Bit	Select stop bit length.
Flow Control	Select the communication control method to prevent overflow of transmission and reception data.
Timeout (s)	Use an integer from 1 to 127 to enter the time (s) for which the Display waits for the response from the External Device.

Setup Items	Setup Description
Retry	In case of no response from the External Device, use an integer from 0 to 255 to enter how many times the Display retransmits the command.
Wait To Send (ms)	Use an integer from 0 to 255 to enter standby time (ms) for the Display from receiving packets to transmitting next commands.

### ■ Device Setting

To display the setting screen, touch [Device/PLC Settings] from [Peripheral Equipment Settings]. Touch the External Device you want to set from the displayed list, and touch [Device].

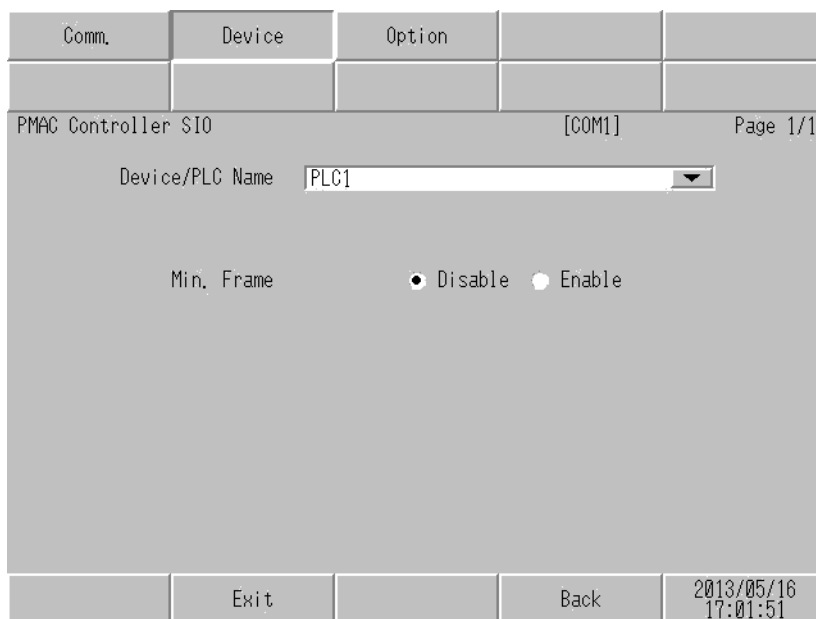

Setup Items	Setup Description
Device/PLC name	Select the External Device to set. The device name is set up in GP-Pro EX. (Initial value [PLC1])
Min. Frame	Set [Min. Frame] to [Enable] to minimize the length of device addresses in communication frames.  For example, M0009 is converted to M9.

■ Option

To display the setting screen, touch [Device/PLC Settings] from [Peripheral Settings]. Touch the External Device you want to set from the displayed list, and touch [Option].

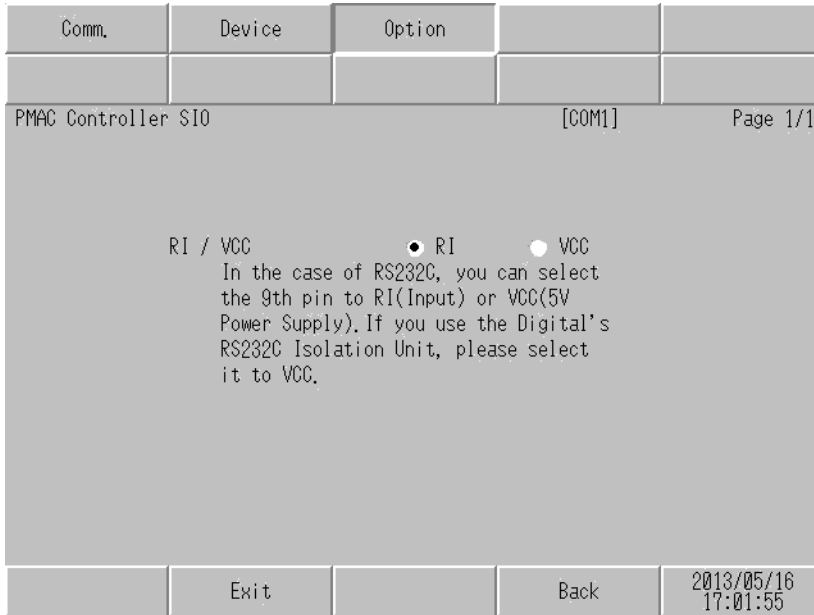

Setup Items	Setup Description
RI/VCC	You can toggle between RI and VCC on the 9th pin. When you connect to the IPC, to toggle between RI and 5V, use the IPC's changeover switch. Please refer to the manual of the IPC for more details.

**NOTE**

- GP-4100 series and GP-4\*0ITM do not have the [Option] setting in the offline mode.

## 5 Cable Diagram

The cable diagram shown below may be different from the cable diagram recommended by Delta-TAU data system, inc. Please be assured there is no operational problem in applying the cable diagram shown in this manual.

- The FG pin of the External Device body must be D-class grounded. Please refer to the manual of the External Device for more details.
- SG and FG are connected inside the Display. When connecting SG to the External Device, design the system not to form short-circuit loop.
- Connect the isolation unit, when communication is not stabilized under the influence of a noise etc.

Cable Diagram 1

Display (Connection Port)	Cable		Notes
GP3000 (COM1) GP4000* <sup>1</sup> (COM1) ST (COM1) LT3000 (COM1) IPC* <sup>2</sup> PC/AT	1A	User-created cable	Cable length: 15m or less
GP-4105 (COM1)	1B	User-created cable	

\*1 All GP4000 models except GP-4100 Series and GP-4203T

\*2 Only the COM port which can communicate by RS-232C can be used.

 "■ IPC COM Port" (page 4)

1A)

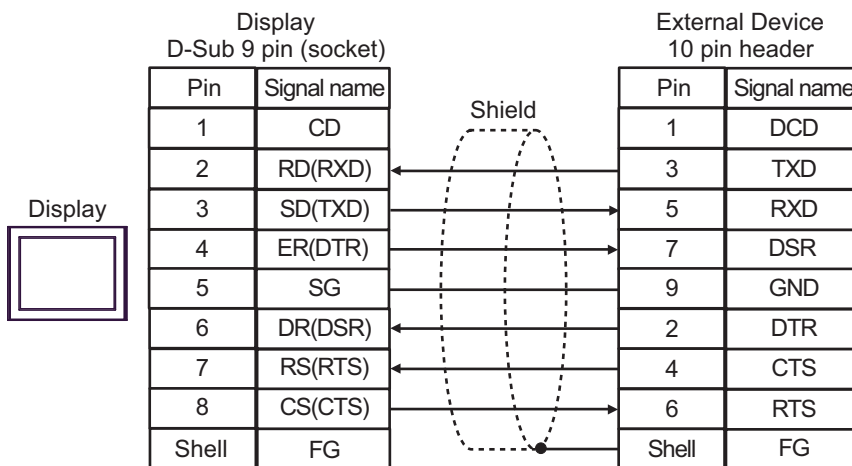

1B)

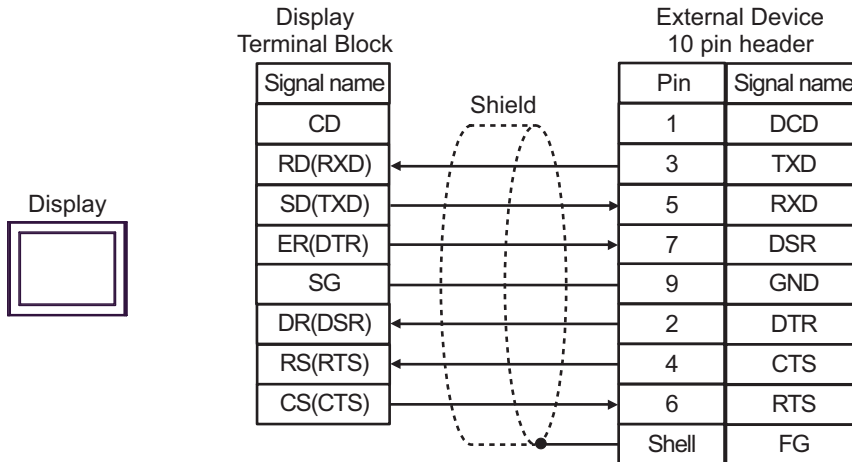







## 6 Supported Devices

The following section shows the range of supported device addresses. Please note that the actual supported range of the devices vary depending on the External Device to be used. Please check the actual range in the manual of your External Device.

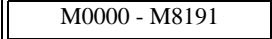
 This address can be specified as system data area.

Device	Bit Address	Word Address	32bits	Notes
I-Device	-	I0000 - I8191	<b>H / L</b>	*1 
P-Device	-	P0000 - P8191		*1 
Q-Device	-	Q0000 - Q8191		*1 
M-Device	-	 M0000 - M8191		*1 

\*1 I, P, Q and M are 48 bit real devices on the External Device. You can also use hexadecimal and decimal values with these devices. However, the Display handles these device addresses as 32-bit devices.

**NOTE**

- Please refer to the GP-Pro EX Reference Manual for system data area.
- Cf. GP-Pro EX Reference Manual "LS Area (Direct Access Method Area)"
- Please refer to the precautions on manual notation for icons in the table.

 "Manual Symbols and Terminology"

## 7 Device Code and Address Code

Use device code and address code when you select "Device Type & Address" for the address type in data displays.

Device	Device Name	Device Code (HEX)	Address Code
I-Device	I	0001	Double Word Address
P-Device	P	0002	Double Word Address
Q-Device	Q	0003	Double Word Address
M-Device	M	0000	Double Word Address
Special Device	SP	0060	Double Word Address <sup>*1 *2</sup>

\*1 Read disable

\*2 Input device for online commands. You can send commands to the PMAC Controller via the SP device without a PMAC Executive Pro Suite (Pewin32 Pro) terminal. When a PMAC controller receives alphanumeric text over the serial port, the PMAC controller interprets the set of alphanumeric characters as a command and executes the command immediately.

## 8 Error Messages

Error messages are displayed on the screen of Display as follows: "No.: Device Name: Error Message (Error Occurrence Area)". Each description is shown below.

Item	Description
No.	Error No.
Device Name	Name of External Device where error occurs. Device name is a title of External Device set with GP-Pro EX. (Initial value [PLC1])
Error Message	Displays messages related to the error which occurs.
Error Occurrence Area	<p>Displays IP address or device address of External Device where error occurs, or error codes received from External Device.</p> <p><b>NOTE</b></p> <ul style="list-style-type: none"> <li>• IP address is displayed such as "IP address (Decimal): MAC address (Hex)".</li> <li>• Device address is displayed such as "Address: Device address".</li> <li>• Received error codes are displayed such as "Decimal [Hex]".</li> </ul>

Display Examples of Error Messages

"RHAA035:PLC1: Error has been responded for device write command (Error Code: 2 [02H])"

**NOTE**

- Refer to your External Device manual for details on received error codes.
- Refer to "Display-related errors" in "Maintenance/Troubleshooting Guide" for details on the error messages common to the driver.