



# XGK Series CPU Direct Driver

1	System Configuration.....	3
2	Selection of External Device .....	6
3	Example of Communication Setting.....	7
4	Setup Items.....	9
5	Cable Diagram .....	13
6	Supported Devices.....	15
7	Device Code and Address Code.....	17
8	Error Messages.....	18

## Introduction

This manual describes how to connect the Display and the External Device (target PLC).

In this manual, the connection procedure will be described by following the below sections:

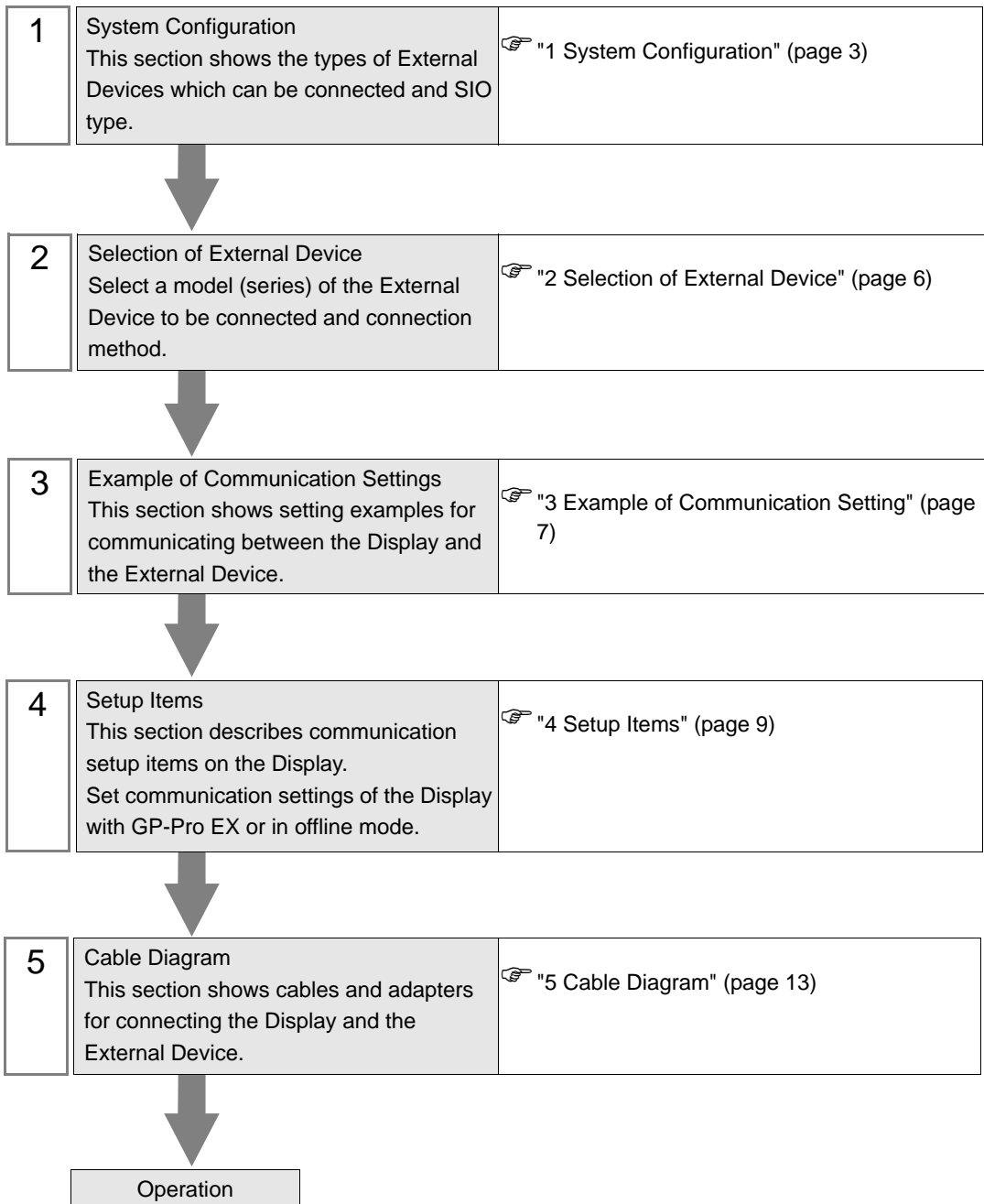

# 1 System Configuration

The system configuration in the case when the External Device of LS Industrial Systems Co.,Ltd. and the Display are connected is shown.

Series	CPU	Link I/F	SIO Type	Setting Example	Cable Diagram
XGK *1	XGK-CPUE XGK-CPUH	Loader port	RS-232C	"Setting Example 1" (page 7)	"Cable Diagram 1" (page 13)

\*1 Supported by CPU Version 3.5 or later.

## ■ Connection Configuration

- 1:1 connection

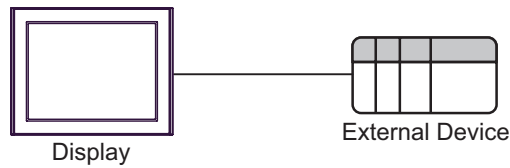

## ■ IPC COM Port

When connecting IPC with an External Device, the COM port used depends on the series and SIO type. Please refer to the IPC manual for details.

### Usable port

Series	Usable Port		
	RS-232C	RS-422/485(4 wire)	RS-422/485(2 wire)
PS-2000B	COM1 <sup>*1</sup> , COM2, COM3 <sup>*1</sup> , COM4	-	-
PS-3450A, PS-3451A, PS3000-BA, PS3001-BD	COM1, COM2 <sup>*1*2</sup>	COM2 <sup>*1*2</sup>	COM2 <sup>*1*2</sup>
PS-3650A (T41 model), PS-3651A (T41 model)	COM1 <sup>*1</sup>	-	-
PS-3650A (T42 model), PS-3651A (T42 model)	COM1 <sup>*1*2</sup> , COM2	COM1 <sup>*1*2</sup>	COM1 <sup>*1*2</sup>
PS-3700A (Pentium®4-M) PS-3710A	COM1 <sup>*1</sup> , COM2 <sup>*1</sup> , COM3 <sup>*2</sup> , COM4	COM3 <sup>*2</sup>	COM3 <sup>*2</sup>
PS-3711A	COM1 <sup>*1</sup> , COM2 <sup>*2</sup>	COM2 <sup>*2</sup>	COM2 <sup>*2</sup>
PS4000 <sup>*3</sup>	COM1, COM2	-	-
PL3000	COM1 <sup>*1*2</sup> , COM2 <sup>*1</sup> , COM3, COM4	COM1 <sup>*1*2</sup>	COM1 <sup>*1*2</sup>

\*1 The RI/5V can be switched. Use the IPC's switch to change if necessary.

\*2 Set up the SIO type with the DIP Switch. Please set up as follows according to SIO type to be used.

\*3 When making communication between an External Device and COM port on the Expansion slot, only RS-232C is supported. However, ER (DTR/CTS) control cannot be executed because of the specification of COM port.

For connection with External Device, use user-created cables and disable Pin Nos. 1, 4, 6 and 9.

Please refer to the IPC manual for details of pin layout.

### DIP Switch setting: RS-232C

DIP Switch	Setting	Description
1	OFF <sup>*1</sup>	Reserved (always OFF)
2	OFF	SIO type: RS-232C
3	OFF	
4	OFF	Output mode of SD (TXD) data: Always output
5	OFF	Terminal resistance (220Ω) insertion to SD (TXD): None
6	OFF	Terminal resistance (220Ω) insertion to RD (RXD): None
7	OFF	Short-circuit of SDA (TXA) and RDA (RXA): Not available
8	OFF	Short-circuit of SDB (TXB) and RDB (RXB): Not available
9	OFF	RS (RTS) Auto control mode: Disabled
10	OFF	

\*1 When using PS-3450A, PS-3451A, PS3000-BA and PS3001-BD, turn ON the set value.

## DIP Switch setting: RS-422/485 (4 wire)

DIP Switch	Setting	Description
1	OFF	Reserved (always OFF)
2	ON	SIO type: RS-422/485
3	ON	
4	OFF	Output mode of SD (TXD) data: Always output
5	OFF	Terminal resistance (220Ω) insertion to SD (TXD): None
6	OFF	Terminal resistance (220Ω) insertion to RD (RXD): None
7	OFF	Short-circuit of SDA (TXA) and RDA (RXA): Not available
8	OFF	Short-circuit of SDB (TXB) and RDB (RXB): Not available
9	OFF	RS (RTS) Auto control mode: Disabled
10	OFF	

## DIP Switch setting: RS-422/485 (2 wire)

DIP Switch	Setting	Description
1	OFF	Reserved (always OFF)
2	ON	SIO type: RS-422/485
3	ON	
4	OFF	Output mode of SD (TXD) data: Always output
5	OFF	Terminal resistance (220Ω) insertion to SD (TXD): None
6	OFF	Terminal resistance (220Ω) insertion to RD (RXD): None
7	ON	Short-circuit of SDA (TXA) and RDA (RXA): Available
8	ON	Short-circuit of SDB (TXB) and RDB (RXB): Available
9	ON	RS (RTS) Auto control mode: Enabled
10	ON	

## 2 Selection of External Device

Select the External Device to be connected to the Display.

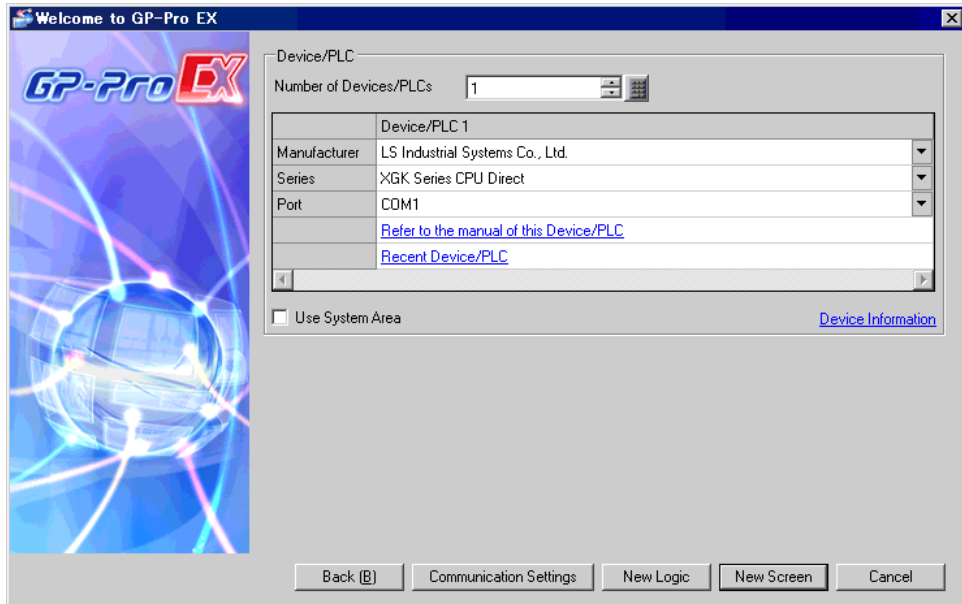

Setup Items	Setup Description
Number of Devices/PLCs	Use an integer from 1 to 4 to enter the number of Devices/PLCs to connect to the display.
Manufacturer	Select the manufacturer of the External Device to be connected. Select "LS Industrial Systems Co.,Ltd."
Series	Select the model (series) of the External Device to be connected and connection method. Select "XGK Series CPU Direct". Check the External Device that you can connect in "XGK Series CPU Direct" in system configuration. ☞ "1 System Configuration" (page 3)
Port	Select the Display port to be connected to the External Device.
Use System Area	Check this option when you synchronize the system data area of Display and the device (memory) of External Device. When synchronized, you can use the ladder program of External Device to switch the display or display the window on the Display. Cf. GP-Pro EX Reference Manual "LS Area (Direct Access Method Area)" This can also be set in GP-Pro EX or in the Display's offline mode. Cf. GP-Pro EX Reference Manual "Display Unit (System Area) Settings Guide" Cf. Maintenance/Troubleshooting Manual "Main Unit - System Area Settings"

## 3 Example of Communication Setting

The following shows examples of communication settings of the Display and the External Device, which is recommended by Pro-face.

### 3.1 Setting Example 1

#### ■ Settings of GP-Pro EX

##### ◆ Communication Settings

To display the setup screen, from the [Project] menu, point to [System Settings] and select [Device/PLC].

Device/PLC 1

Summary [Change Device/PLC](#)

Manufacturer  Series  Port

Text Data Mode  [Change](#)

Communication Settings

SIQ Type  RS232C  RS422/485(2wire)  RS422/485(4wire)

Speed

Data Length  7  8

Parity  NONE  EVEN  ODD

Stop Bit  1  2

Flow Control  NONE  ER(DTR/CTS)  XON/XOFF

Timeout  (sec)

Retry

Wait To Send  (ms)

RI / VCC  RI  VCC

In the case of RS232C, you can select the 9th pin to RI (Input) or VCC (5V Power Supply). If you use the Digital's RS232C Isolation Unit, please select it to VCC.

Device-Specific Settings

Allowable Number of Devices/PLCs  [Add Device](#)

No.	Device Name	Settings
<input type="button" value="Add"/> 1	<input type="text" value="PLC1"/>	<input type="button" value="Settings"/>

[Add Indirect Device](#)

## ■ Settings of External Device

External Device communication settings are fixed as indicated below.

Setup Items	Setting Value
Communication speed	115200
Data length	8
Stop bit	1
Parity	None



## 4 Setup Items

Set communication settings of the Display with GP-Pro EX or in offline mode of the Display.

The setting of each parameter must be identical to that of External Device.

☞ "3 Example of Communication Setting" (page 7)

### 4.1 Setup Items in GP-Pro EX

#### ■ Communication Settings

To display the setup screen, from the [Project] menu, point to [System Settings] and select [Device/PLC].

Setup Items	Setup Description
SIO Type	Displays SIO type.
Speed	Displays the transmission speed.
Data Length	Displays the data length.
Parity	Displays the parity.
Stop Bit	Displays the stop bit length.
Flow Control	Displays the flow control.
Timeout	Use an integer from 1 to 127 to define the time (in seconds) the Display waits for a response from the External Device.
Retry	When there is no response from the External Device, use an integer from 0 to 255 to define how many times the Display retransmits the command.
Wait To Send	Use an integer from 0 to 255 to define the standby time (in milliseconds) the Display waits after receiving packets until transmitting the next command.
RI/VCC	You can toggle between RI and VCC on the 9th pin when the SIO type is RS232C. When you connect to the IPC, to toggle between RI and 5V, use the IPC's changeover switch. Please refer to the manual of the IPC for more details.

**NOTE**

- Refer to the GP-Pro EX Reference Manual for Indirect Device.  
Cf. GP-Pro EX Reference Manual "Changing the Device/PLC at Runtime (Indirect Device)"
-

## 4.2 Setup Items in Offline Mode

**NOTE**

- Please refer to Maintenance/Troubleshooting Guide for more information on how to enter offline mode or about operation.  
Cf. Maintenance/Troubleshooting Guide "Offline Mode"
- The number of the setup items to be displayed for 1 page in the offline mode depends on the Display in use. Please refer to the Reference manual for details.

■ Communication Settings

To display the setting screen, touch [Device/PLC Settings] from [Peripheral Settings] in offline mode. Touch the External Device you want to set from the displayed list.

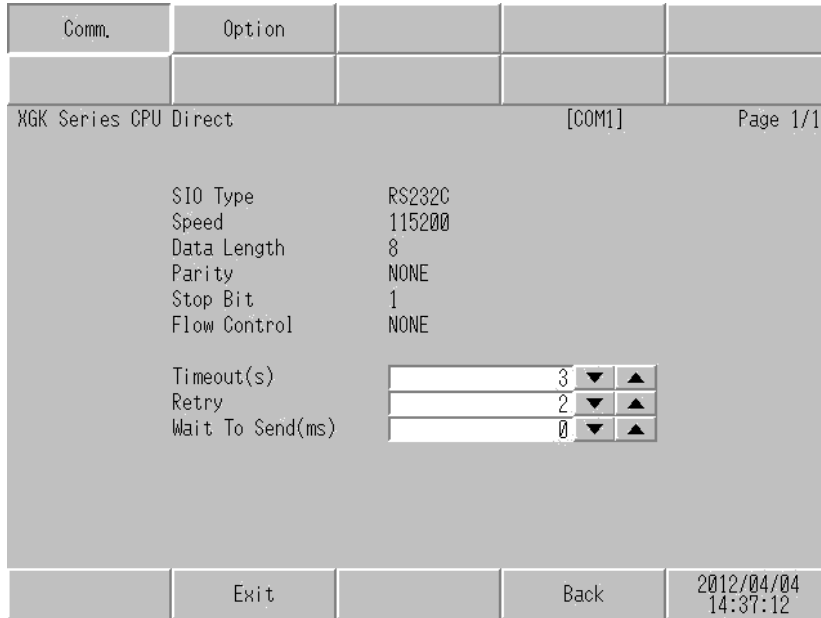

Setup Items	Setup Description
SIO Type	Displays SIO type.
Speed	Displays the transmission speed.
Data Length	Displays the data length.
Parity	Displays the parity.
Stop Bit	Displays the stop bit length.
Flow Control	Displays the flow control.
Timeout (s)	Use an integer from 1 to 127 to define the time (in seconds) the Display waits for a response from the External Device.
Retry	When there is no response from the External Device, use an integer from 0 to 255 to define how many times the Display retransmits the command.
Wait To Send (ms)	Use an integer from 0 to 255 to define the standby time (in milliseconds) the Display waits after receiving packets until transmitting the next command.

## ■ Option

To display the setting screen, touch [Device/PLC Settings] from [Peripheral Settings]. Touch the External Device you want to set from the displayed list, and touch [Option].

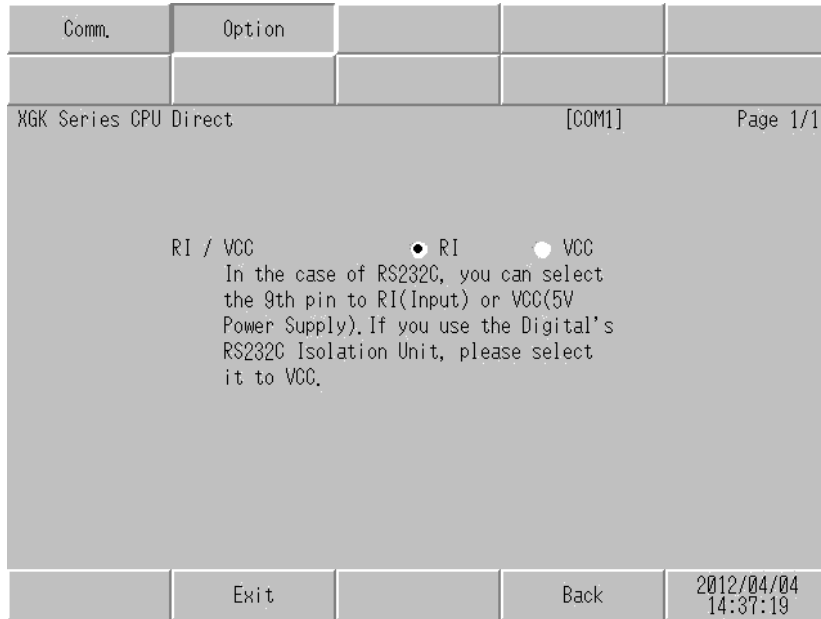

Setup Items	Setup Description
RI/VCC	You can toggle between RI and VCC on the 9th pin. When you connect to the IPC, to toggle between RI and 5V, use the IPC's changeover switch. Please refer to the manual of the IPC for more details.

### NOTE

- GP-4100 series and GP-4\*0ITM do not have the [Option] setting in the offline mode.

## 5 Cable Diagram

The cable diagram shown below may be different from the cable diagram recommended by LS Industrial Systems Co., Ltd. Please be assured there is no operational problem in applying the cable diagram shown in this manual.

- The FG pin of the External Device body must be D-class grounded. Please refer to the manual of the External Device for more details.
- SG and FG are connected inside the Display. When connecting SG to the External Device, design the system not to form short-circuit loop.
- Connect the isolation unit, when communication is not stabilized under the influence of a noise etc.

Cable Diagram 1

Display (Connection Port)	Cable		Notes
GP3000 (COM1) GP4000* <sup>1</sup> (COM1) ST (COM1) LT (COM1) IPC* <sup>2</sup> PC/AT	1A	User-created cable	Cable length: 15m or less
GP-4105 (COM1)	1B	User-created cable	

\*1 All GP4000 models except GP-4100 Series and GP-4203T

\*2 Only the COM port which can communicate by RS-232C can be used.  
 "■ IPC COM Port" (page 4)

1A)

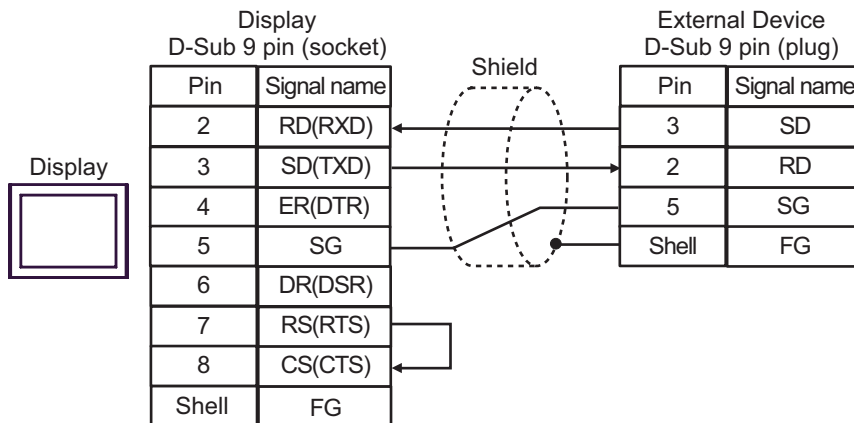

1B)

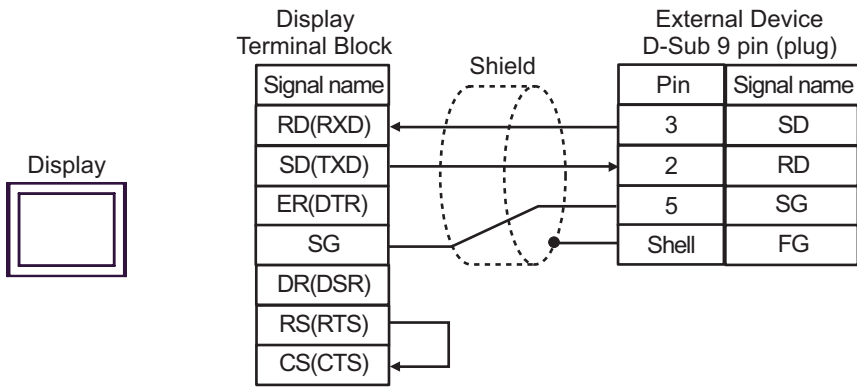

## 6 Supported Devices

The following section shows the range of supported device addresses. Please note that the actual supported range of the devices vary depending on the External Device to be used. Please check the actual range in the manual of your External Device.

### 6.1 XGK-CPUH

     This address can be specified as system data area.

Device	Bit Address	Word Address	32bits	Notes
Input / Output Relay	P00000 - P2047F	P0000 - P2047	L / H	*1
Auxiliary Relay	M00000 - M2047F	M0000 - M2047		*1
Keep Relay	K00000 - K2047F	K0000 - K2047		*1
Link Relay	L000000 - L11263F	L00000 - L11263		*1
Special Relay	F00000 - F2047F	F0000 - F2047		*2
Timer(Contact)	T0000 - T2047	-		*1
Counter(Contact)	C0000 - C2047	-		*1
Timer(Current Value)	-	T0000 - T2047		
Counter(Current Value)	-	C0000 - C2047		
Step Controller	-	S000 - S127		*3
Data Register	-	D00000 - D32767		Bit F
Special Module Register	-	U00.00 - U7F.31		Bit F *4
Index Register	-	Z000 - Z127		
Communication Data Register	-	N00000 - N21503		
File Register	-	R00000 - R32767	Bit F	
File Register	-	ZR00000 - ZR65535	Bit F	

\*1 When you write to the bit address, the Display reads the entire word, sets the defined bit, then returns the new word value to the External Device. If the ladder program writes data to this word address during the bit write process, the resulting data may be incorrect.

\*2 Write disabled.

\*3 Word access only to S devices.

To turn on a bit, write the bit number to the word address.

e.g. To turn on S000.03, write 3 to S000.

Cannot turn on multiple bits.

All bits are turned off when the number written to the word address does not correspond to a bit number.



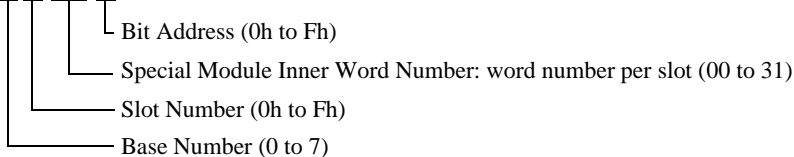

\*4 The device address format is as follows:

U7F.31.F

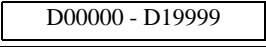

6.2 XGK-CPUE

 This address can be specified as system data area.

Device	Bit Address	Word Address	32bits	Notes
Input / Output Relay	P00000 - P2047F	P0000 - P2047	<b>L / H</b>	*1
Auxiliary Relay	M00000 - M2047F	M0000 - M2047		*1
Keep Relay	K00000 - K2047F	K0000 - K2047		*1
Link Relay	L000000 - L11263F	L00000 - L11263		*1
Special Relay	F00000 - F2047F	F0000 - F2047		*2
Timer (Contact)	T0000 - T2047	-		*1
Counter (Contact)	C0000 - C2047	-		*1
Timer (Current Value)	-	T0000 - T2047		
Counter (Current Value)	-	C0000 - C2047		
Step Controller	-	S000 - S127		*3
Data Register	-	 D00000 - D19999		
Special Module Register	-	U00.00 - U1F.31		 *4
Index Register	-	Z000 - Z127		
Communication Data Register	-	N00000 - N21503		
File Register	-	R00000 - R32767		
File Register	-	ZR00000 - ZR32767		

\*1 When you write to the bit address, the Display reads the entire word, sets the defined bit, then returns the new word value to the External Device. If the ladder program writes data to this word address during the bit write process, the resulting data may be incorrect.

\*2 Write disabled.

\*3 Word access only to S devices.  
 To turn on a bit, write the bit number to the word address.  
 e.g. To turn on S000.03, write 3 to S000.  
 Cannot turn on multiple bits.  
 All bits are turned off when the number written to the word address does not correspond to a bit number.

\*4 The device address format is as follows:

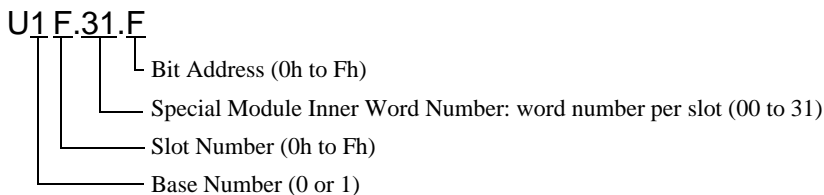



## 7 Device Code and Address Code

Use device code and address code when you select "Device Type & Address" for the address type in data displays.

Device	Device Name	Device Code (HEX)	Address Code
Input / Output Relay	P	0080	Word Address
Auxiliary Relay	M	0082	Word Address
Keep Relay	K	0083	Word Address
Link Relay	L	0084	Word Address
Special Relay	F	0085	Word Address
Timer (Current Value)	T	0060	Word Address
Counter (Current Value)	C	0061	Word Address
Step controller	S	0062	Word Address
Data Register	D	0000	Word Address
Special Module Register	U	0002	Word Address <sup>*1</sup>
Index Register	Z	0063	Word Address
Communication Data Register	N	0064	Word Address
File Register	R	0001	Word Address
File Register	ZR	0003	Word Address

\*1 Internally 'Address Indirect specification' is supported in case of U device.

When it is Uxx.dd, the converted formula is like this:

Hex type: [ $\text{'xx' part}$ ]  $\times$  h20 + [the hexadecimal value of 'dd' part]

Dec type: [the decimal value of 'xx' part]  $\times$  32 + ['dd' part]

(Here, 'xx' is also a hexadecimal type, 'dd' is also a decimal type.)

For example, '01.00' is converted into '0x20 (=32)', '10.00' is converted into '0x200 (=512)', '7F.00' is converted into '0xFE0 (=4064)' and so on.

## 8 Error Messages

Error messages are displayed on the screen of Display as follows: "No.: Device Name: Error Message (Error Occurrence Area)". Each description is shown below.

Item	Description
No.	Error No.
Device Name	Name of External Device where error occurs. Device name is a title of External Device set with GP-Pro EX. (Initial value [PLC1])
Error Message	Displays messages related to the error which occurs.
Error Occurrence Area	Displays IP address or device address of External Device where error occurs, or error codes received from External Device. <div style="border: 1px solid black; padding: 2px; margin: 5px 0;"><b>NOTE</b></div> <ul style="list-style-type: none"> <li>IP address is displayed such as "IP address (Decimal): MAC address (Hex)".</li> <li>Device address is displayed such as "Address: Device address".</li> <li>Received error codes are displayed such as "Decimal [Hex]".</li> </ul>

Display Examples of Error Messages

"RHAA035:PLC1: Error has been responded for device write command (Error Code: 2 [02H])"

**NOTE**

- Refer to your External Device manual for details on received error codes.
- Refer to "Display-related errors" in "Maintenance/Troubleshooting Guide" for details on the error messages common to the driver.

### ■ Error Codes Unique to External Device

Error codes unique to External Device are shown below.

Error Code	Description	PLC Error Code
26990(696EH)	Data size error (exceeding 127 words) for Block Write command.	'AKinvalid_resetLFCR'
12336(3030H)	Illegal command format.	'NK0060ET'
12339(3033H)	Illegal device for Random Read command.	'NK03ET'
12340(3034H)	Out of address range for Block read/write.	'NK04ET'
12353(3041H)	Out of address range for Monitor registration.	'NK0AET'
12344(3038H)	Illegal registration ID for Monitor command.	'NK08ET'